

PRODUCTS

BULKHEAD PRODUCT RANGE



Product details

CIB

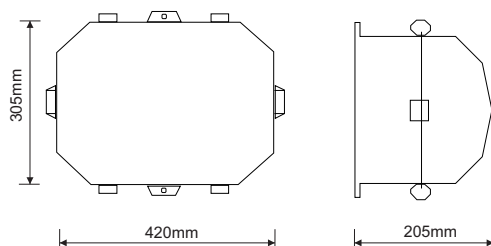

CDB

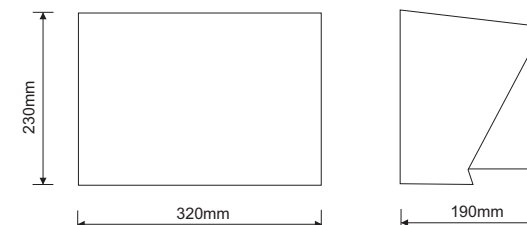

Features

- Robust powder coated cast aluminium housing.
- Borosilicate glass diffuser.
- Integral control gear.

Features

- Robust powder coated cast aluminium housing.
- Borosilicate glass diffuser.
- Integral control gear.

Benefits

- Ceiling /Wall mounted.
- Stainless steel clips.
- Ingress protection rating - IP 65.

Applications

- Tunnels
- Corridors
- Building perimeters
- Conveyors
- Canopies

Warranty

3 year warranty

NOTE: Products must be installed by a qualified electrician

PRODUCTS

BULKHEAD PRODUCT RANGE



Product details

MBECO



Features

- ABS base.
- Polycarbonate diffuser.
- Integrally moulded bracket for lamp.
- Hinged reflector plate for easy installation.

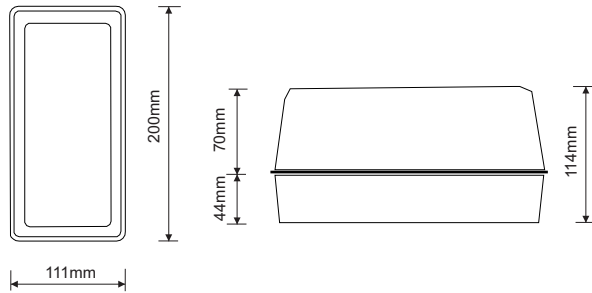

MBREC



Features

- Polycarbonate base.
- Polycarbonate diffuser.
- Integral control gear.
- Available in ECG.
- Photocell option.

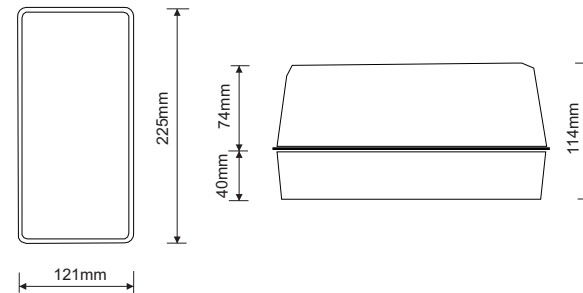

MBUFO

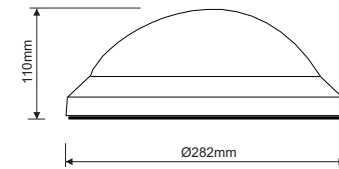

MBLUNA

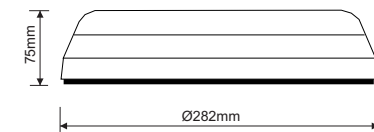

MBR

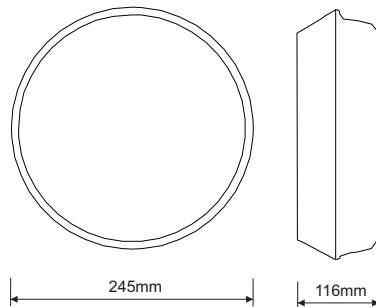

Features

- Polycarbonate base.
- Polycarbonate prismatic diffuser.
- Integral control gear.
- Photocell option.
- Available in ECG.
- Splash proof.

Features

- Polycarbonate base.
- Clear or opal polycarbonate diffuser.
- Integral control gear.
- Photocell option.

Benefits

- Ceiling /Wall mounted.
- UV stabilised for long life.
- Indoor or outdoor use.
- Ingress protection rating - IP 65.

Applications

- Corridors
- Entrances & exits
- Commercial buildings
- Domestic
- Staircases
- Hospitals & schools

NOTE: Products must be installed by a qualified electrician